

IWAKI  
METERING  
PUMPS

**LK**

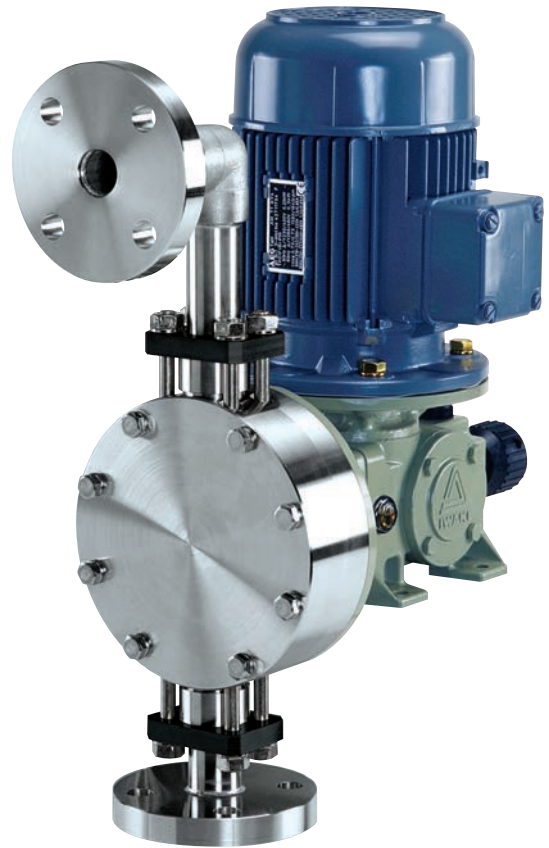

# Applicable to the many diverse needs of chemical feeding

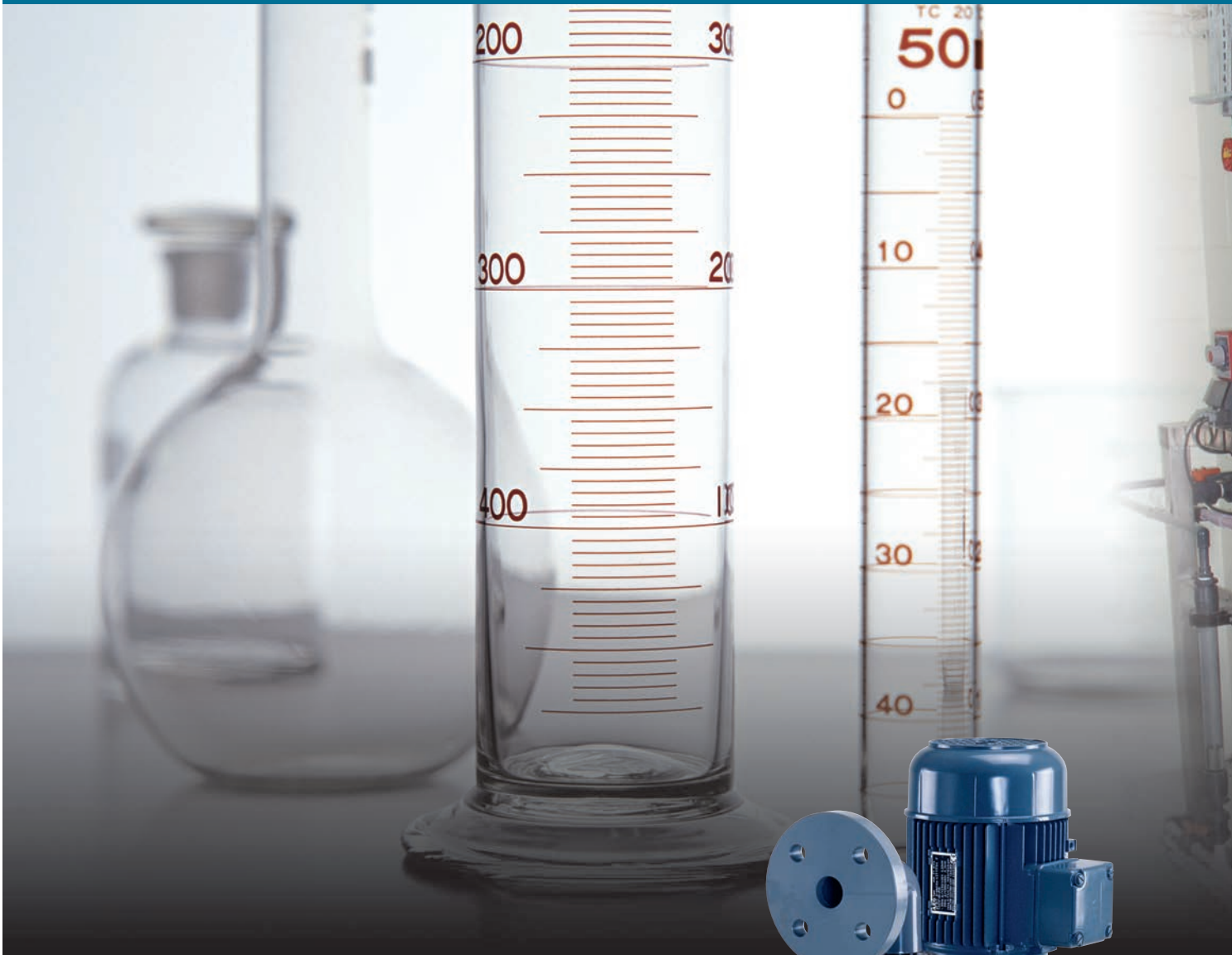

Iwaki's LK series metering pump consists of the worm gear type dual-cam driving section, which is compact yet rigid and reliable. With long and market-proven experience, Iwaki has employed state-of-the-art pump technologies in the development of an ideal type of chemical feeding pump which has advantages such as quality, performance, ease of operation and cost efficiency. The LK series is suitable for many chemical liquid feeding processes used in a wide range of fields, including water treatment, chemicals, fabrics, paper mill, food processing, and medicine.



LK-F57VCT



**Various types and materials**

The LK series is available to suit each user's needs in accordance with feeding rate from small to large capacity. Also, material variation has been improved. Selection of the pump material most suitable for the applied liquid is possible with six different types available.

**High performance and application-oriented versatile design.**

Discharge accuracy (stability) is within  $\pm 2\%$  FS. Reliability is considerably enhanced through efforts to improve the linearity of the stroke / discharge ratio as well as the dispersion between stroke.

Two types of joints flange and hose joints are standardized for the connections. (LK-F11 to LK-F47) The optimum piping system can be selected.



LK-F57S6T



LK-C86VCT

## Construction

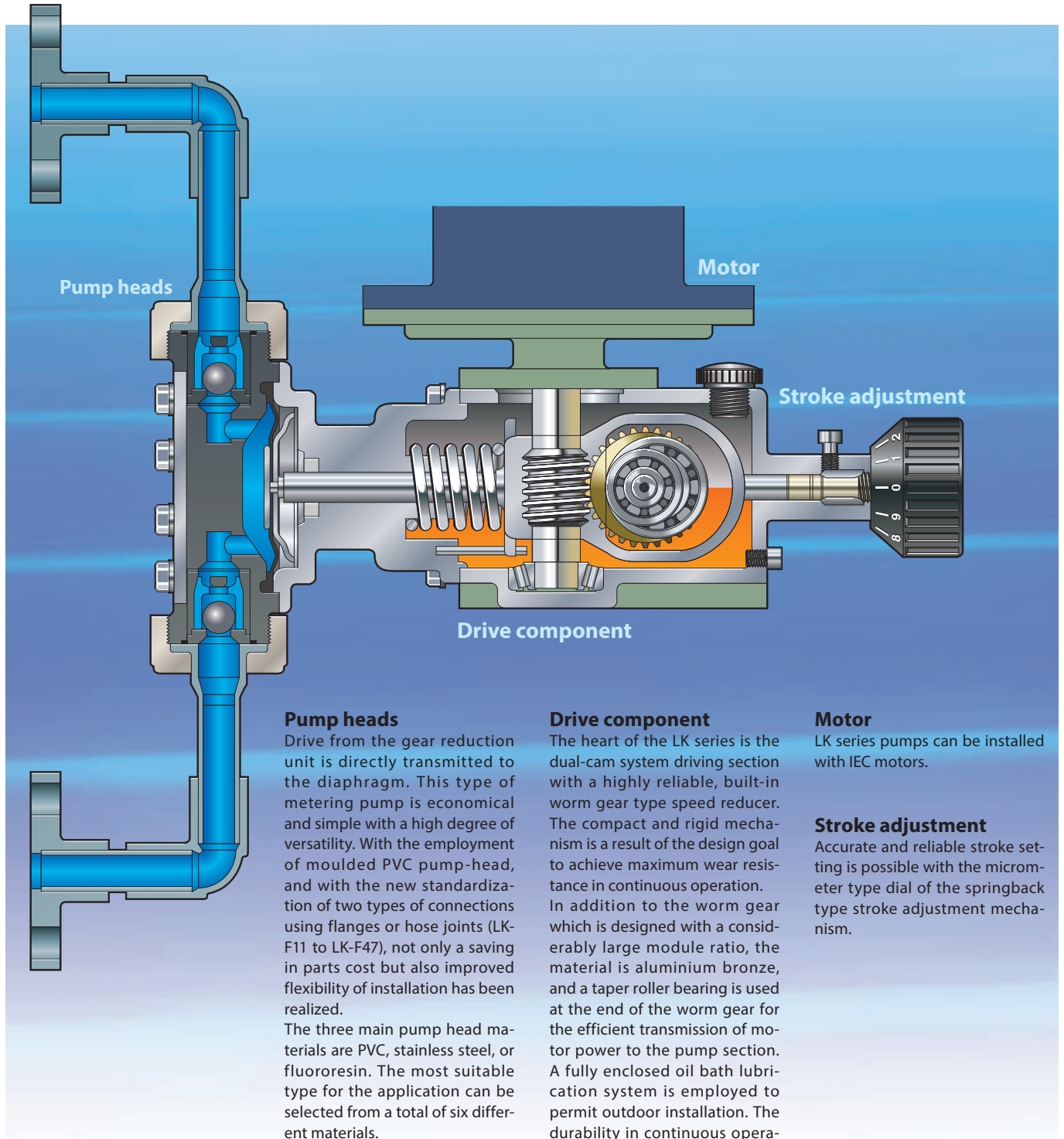

### Pump heads

Drive from the gear reduction unit is directly transmitted to the diaphragm. This type of metering pump is economical and simple with a high degree of versatility. With the employment of moulded PVC pump-head, and with the new standardization of two types of connections using flanges or hose joints (LK-F11 to LK-F47), not only a saving in parts cost but also improved flexibility of installation has been realized.

The three main pump head materials are PVC, stainless steel, or fluororesin. The most suitable type for the application can be selected from a total of six different materials.

### Drive component

The heart of the LK series is the dual-cam system driving section with a highly reliable, built-in worm gear type speed reducer. The compact and rigid mechanism is a result of the design goal to achieve maximum wear resistance in continuous operation. In addition to the worm gear which is designed with a considerably large module ratio, the material is aluminium bronze, and a taper roller bearing is used at the end of the worm gear for the efficient transmission of motor power to the pump section. A fully enclosed oil bath lubrication system is employed to permit outdoor installation. The durability in continuous operation over a long period of time is also excellent.

### Motor

LK series pumps can be installed with IEC motors.

### Stroke adjustment

Accurate and reliable stroke setting is possible with the micrometer type dial of the springback type stroke adjustment mechanism.



## Materials

Type	VC	VH	VS4	S6	S4		
<b>Application</b>	Acids	Alkalines		Solvents			
<b>Applicable type</b>	11 to 87	11 to 57	65 to 87	11 to 57	65 to 87		
<b>Part</b>	<b>Pump head</b>	PVC	PVC	PVC	SUS316	SCS13	
	<b>Valve</b>	CE	HC	SUS304	HC	SUS304	
	<b>Valve seat</b>	<b>Type 11 to 32</b>	FKM	EPDM	-	SUS316	-
		<b>Type 45 to 87</b>	PVC	PVC	PVC	SUS316	SUS304
	<b>O ring</b>	FKM	EPDM	EPDM	-	-	
<b>Valve gasket</b>	PTFE		-	PTFE			
<b>Diaphragm</b>	PTFE coated EPDM						
<b>Liquid temp. range</b> *	0 - 50°C			0 - 80°C			

※: Liquid temp. range is varied by handling chemical. Please contact us.

<b>Typical chemicals</b>	<b>Material symbols</b>
<b>VC:</b> Sulfuric acid, Hydrochloric acid, Sodium hypochlorite	<b>SCS13:</b> Stainless-steel equivalent to SUS304
<b>VH, VS4:</b> Caustic soda, Coagulant, Calcium hydroxide (low density)	<b>CE:</b> Ceramic
<b>TC:</b> Concentrated sulfuric acid, Hydrofluoric acid, Mixed acid	<b>FKM:</b> Fluoro rubber
<b>S6, S4:</b> Organic solvent, Paper making chemicals	<b>HC:</b> Hastelloy C276

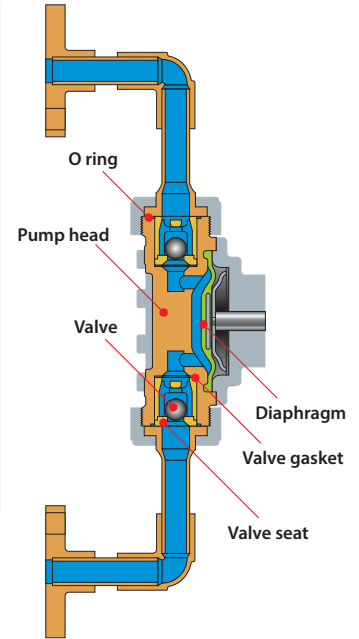

Note: VS type for viscosity and slurry is available on special request. Please contact us for details.  
For information of TC type, please contact IWAKI or nearest distributor.

## Identification

**LK - F 32 VC T**

- Series name**  
LK series: Mechanical driven diaphragm type
- Drive section**  
F: 0.25kW, A: 0.37kW, B: 0.75kW, C: 1.5kW
- Type No.**  
First digit : Diaphragm (pump head size)  
Second digit : Speed-reducing gear ratio 1: 1/30, 2: 1/15, 5: 1/30, 6: 1/20, 7: 1/15
- Material symbol**  
Refer to the material table (ex. VC, VH, VS4, TC, S6, S4)
- Connection**  
None: Flange ("JIS" or others), T: Flange ("DIN"), H: Hose

## Specifications

Model	Capacity L/min <small>Note 1</small>	Max. Pressure MPa		Stroke speed spm	Effective diaphragm dia. mm	Max. stroke length mm	Connection				Motor output (4 Pole)
		Flange					Hose				
		PVC, PVDF	SUS				PVC	PVDF <small>Note 2</small>			
LK-F11	0.02	1.0	1.5	48	22	1.5	DN15 (DIN PN10)	DN15 (DIN PN16)	ID4mm (or 5mm) OD9mm	-	0.25kW
F21	0.05	1.0	1.5	48	30	2.0					
F22	0.10	1.0	1.5	96	30	2.0					
F31	0.25	1.0	1.5	48	60	2.5					
F32	0.50	1.0	1.5	96	60	2.5					
F45	0.85	1.0	1.5	48	72	6.0					
F47	1.7	0.8	0.8	96	72	6.0	DN25 (DIN PN10)	-	-	0.37kW	
F55	2.8	0.5	0.5	48	100	10					
F57	6.0	0.3	0.3	96	100	10					
LK-A55	2.8	0.7	0.7	48	100	10	DN25 (DIN PN10)	-	-	0.75kW	
A57	6.0	0.5	0.5	96	100	10					
A65	9.0	0.2	0.2	48	138	17.5					
LK-B65	9.0	0.5	0.7	48	138	17.5	DN40 (DIN PN10)	-	-	1.5kW	
B75	13.3	0.5	0.5	48	150	20					
LK-C76	20.0	0.5	0.5	72	150	20	DN50 (DIN PN10)	-	-		
C86	33.0	0.3	0.3	72	205	20					
C87	45.0	0.3	0.3	96	205	20					

Note: The capacity is the value when maximum discharge pressure is applied (with pure water at room temperature).  
The value may be larger than indicated in the table if the discharge pressure is lower.

- Standard accessory : A siphon preventing valve, strainer and 4m PVC tube are furnished to hose connection type of LK-F11 to LK-F45VCH or VHH. A base is furnished to all LK-A, LK-B and LK-C models.
- Frequency control is applicable. Please contact us for details.

## Dimensions in mm

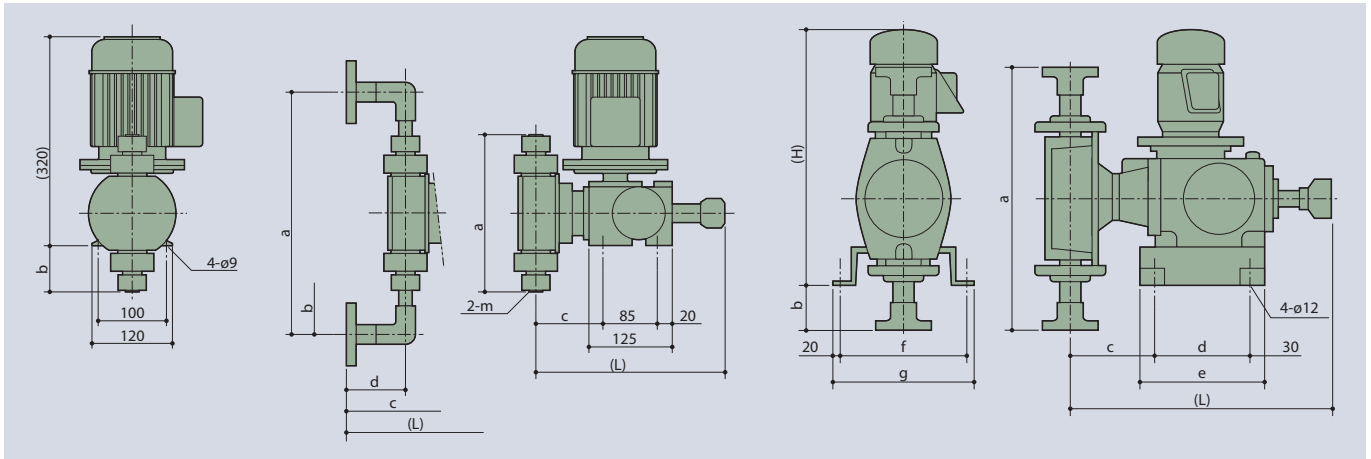

Note: All illustrations above show "PVC" type. The suction flange made of SUS is straight.

### LK-F11 to LK-F57

Model	Hose type					Flange type								
	PVC					PVC				SUS				
	L	a	b	c	m	L	a	b	c	d	L	a	b	c
LK-1	275	146	23	95	Note	(363)	272	86	94	89	332	156	20	92
2	275	164	32	95		(363)	290	95	94	89	332	166	25	92
3	277	224	62	97		(366)	350	125	97	89	337	201	42	97
4	281	243	72	99		(370)	369	135	99	89	343	270	80	101
5	-	-	-	-		(395)	350	125	114	97	399	368	110	111

Note: Connection size LK-1, LK-2 ø4x ø9 and LK-3, LK-4 ø12 x ø18.

For information of TC type, please contact IWAKI or nearest distributor.

Dimensions and configurations may be changed without prior notice for the purpose of product improvement. Be sure to carry out installation work with the most recent and detailed drawings which are available upon request. The dimensions may differ with the type of motor installed.

### LK-A55 to LK-C87

Model	PVC				SUS				Note				
	L	a	b	c	L	a	b	c	H	d	e	f	g
LK-A5	476	325	-29	111	473	320	-32	108	547	180	240	260	300
A6	523	599	108	154	533	431	24	164	547	180	240	260	300
B6	595	599	90	164	605	431	6	174	594	240	300	310	350
B7	599	600	90	167	610	465	23	178	594	240	300	310	350
C7	599	600	90	167	610	465	23	178	601	240	300	310	350
C8	605	647	114	173	609	633	107	177	601	240	300	310	350

Note: These dimensions are common between PVC pump head and SUS pump head.

For information of TC type, please contact IWAKI or nearest distributor.

## Points to be observed in pump installation and piping

Iwaki metering pump LK series are reciprocating pumps employing the eccentric cam system.

Reciprocating pumps generate pulsation in the suction and discharge piping. Special consideration,

(different from the ordinary centrifugal pumps), should be given to this point when planning the pump installation and piping.

### • Prevention of pipe vibration

Discharge side inertial resistance  $P_{id} < 0.1\text{MPa}$

•  $P_{id}$  : Inertial resistance on discharge side

Inertial resistance means the pulsated impact force generated by the flow just upon entering discharge stroke. It is a phenomenon particular to a reciprocating pump which is generated as a result of the sudden application of acceleration to the liquid in the discharge piping.

The condition " $P_{id} < 0.1\text{MPa}$ " is given above as an approximate standard. If  $P_{id}$  becomes  $0.1\text{MPa}$  or higher, vibration on the pipe is generated. So measures should be taken to cope with the influence of vibration on the pump, too.

#### Measures

1. Install pulsation prevention device (air chamber).
2. Enlarge the diameter and shorten the length of the discharge piping.

### • Prevention of overfeeding

Pump differential pressure  $>$  Inertial resistance  $P_i$

• The larger one of the suction side or the discharge side

Overfeeding means excessive flow of the liquid due to abnormal functioning of the check valve caused by pulsation of the liquid in the piping. Check carefully in case the differential pressure is low and in case the piping is too long even with the differential pressure value at  $0.03\text{MPa}$ .

#### Measures

1. Install air chamber.
2. Install back pressure valve

### • Prevention of suction failure

$NPSH_a > NPSH_r$

$NPSH_a = P_a - P_v \pm P_{hs} - P_{is} \text{ MPa}$

\*Or  $P_{fs}$  : whichever is the larger.

(NPSH : Net positive suction head)

If NPSH<sub>a</sub> is not sufficient, the pump may be damaged by the flow-break or cavitation generated under such conditions.

- NPSH<sub>a</sub> : Absolute NPSH (MPa)
- NPSH<sub>r</sub> : Required NPSH (value particular to the pump) (MPa)
- P<sub>a</sub> : Absolute pressure onto the tank liquid surface (MPa)
- P<sub>v</sub> : Liquid vapour pressure (MPa)
- P<sub>hs</sub> : Pressure caused by the height of the suction side (MPa)  
(Flooded suction : +, Negative suction : -)
- P<sub>is</sub> : Inertial resistance on the suction side (MPa)
- P<sub>fs</sub> : Piping resistance on the suction side (MPa)

## Optional accessories

### Siphon preventing valve



Model	BVC-1P□L-□H		BVC-1P□-□H
Applicable capacity	Up to 1L/min		
Setting pressure	0.05 - 0.2MPa		0.2 - 0.8MPa
Material	PVC, FKM (EPDM)		
Connection mm (Applicable tube diameter)	Inlet	4 x 9, 12 x 18	
	Outlet	R3/8 and R1/2	

□ : Symbol for material of O-ring ("V" for FKM, "E" for EPDM)

### Air chamber



Body	Model	Applicable capacity L	Setting pressure MPa	Connection Nominal size DIN PN10 flange	Weight kg
PVC	A-1V□-S	1.0	0.5	Common for 15 - 25	2
	A-2V□-S	2.0			2.5
	A-5V□-S	5.0			4.5
	N40A-10V(2)-FS *	10			16
	N50A-20V(2)-FS *	20			26
SUS316	A-0556-15S	0.5	0.9	15, 25, 40, 50, 65	15
	A-156-( ) S	1.5			3
	A-556-( ) S	5.0			5
	A-1056-( ) S	10			12
	A-2056-( ) S	20			15
	A-3656-( ) S	36			29
					55

\*: Materials of O-rings: "CR" for 10V / 20V and "FKM" for 10V2 / 20V2

□ : Symbol for material of O-ring ("V" for FKM, "E" for EPDM)

( ) : Symbol for connection (10, 15, 20, 25, 40, 50 or 65)

Note1: The weight is the value of the product only. (The weight of liquid applied is not included.)

Note2: Rigid PVC chamber may deteriorate with ultraviolet ray or the applied chemical liquid over a long period of time. The chamber should be replaced every three years to guarantee safety.

### Relief valve and back pressure valve

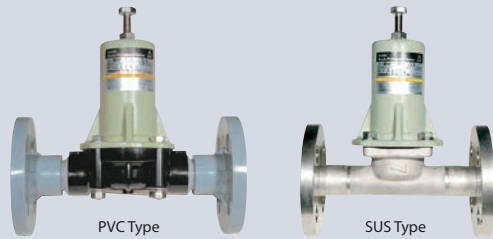

#### List of relief valve

Body	Model	Max. capacity L/min	Setting pressure MPa	Connection Nominal size DIN PN10 flange, unless otherwise specified	Weight kg
PVC	RV-1P□-4H	1.0	0.3 - 0.8	ø4 x ø9 PVC Hose	0.2
	RV-1P□-12H	1.0	0.3 - 0.8	ø12 x ø18 PVC Hose	0.2
	RV-1P□-15S	1.0	0.3 - 0.8	15	0.5
	RV-1P□B-15S	1.0	0.8 - 1.0	15	0.5
	RV-3P-15S	3.0	0.3 - 1.0	15	0.6
	RV-3P-25S	3.0	0.3 - 1.0	25	0.9
	RV-3P□-12H	3.0	0.3 - 1.0	ø12 x ø18 PVC Hose	0.4
	RV-7V-25S	7.5	0.3 - 0.8	25	3.5
	RV-7VB-25S	7.5	0.8 - 1.0	25	3.5
	RV-25V-25S	25	0.3 - 0.8	25	4.0
	RV-25V-40S	25	0.3 - 0.8	40	4.0
	N50RV-5V-FS	45	0.15 - 0.5	50	18
	N50RV-5V2-FS	45	0.15 - 0.5	50	18
	N65-50RV-5V-FS	65	0.15 - 0.5	65	18
	N65-50RV-5V2-FS	65	0.15 - 0.5	65	18
SUS	RV-256-15S	2.0	0.3 - 0.8	15	3.5
	RV-256B-15S	2.0	0.8 - 1.5	15	3.5
	RV-756-25S	7.5	0.3 - 0.8	25	6
	RV-756B-25S	7.5	0.8 - 1.5	25	6
	RV-2556-25S	25	0.3 - 0.8	25	7.0
	RV-2556B-25S	25	0.8 - 1.0	25	7.0
	RV-2556-40S	25	0.3 - 0.8	40	7.5
	RV-2556B-40S	25	0.8 - 1.0	40	7.5
	N50RV-556-FS	75	0.15 - 0.5	50	29
	N65RV-556-FS	120	0.15 - 0.5	65	42

□ : Symbol for material of O-ring ("V" for FKM, "E" for EPDM)

O-ring material of N type is FKM for "SV2".

Note: Material for diaphragm is PTFE except RV-1P and N type.

O-Ring material for "RV-1P" and "N" type is same as diaphragm material.

#### List of back pressure valve

Body	Model	Flow range L/min	Setting pressure MPa	Connection Nominal size DIN PN10 flange, unless otherwise specified	Weight kg
PVC	BV-1P□-4H	0.005 - 1.0	0.2 - 0.8	ø4 x ø9 PVC Hose	0.2
	BV-1P□-12H	0.005 - 1.0	0.2 - 0.8	ø12 x ø18 PVC Hose	0.2
	BV-1P□-15S	0.005 - 1.0	0.2 - 0.8	15	0.5
	BV-1P□L-4H	0.005 - 1.0	0.05 - 0.2	ø4 x ø9 PVC Hose	0.2
	BV-1P□L-12H	0.005 - 1.0	0.05 - 0.2	ø12 x ø18 PVC Hose	0.2
	BV-1P□L-15S	0.005 - 1.0	0.05 - 0.2	15	0.5
	BV-3P□-12H	0.03 - 3.0	0.1 - 0.8	ø12 x ø18 PVC Hose	0.4
	BV-3N□-12H	0.03 - 3.0	0.1 - 0.3	ø12 x ø18 PVC Hose	0.4
	BV-3P-15S	0.03 - 3.0	0.1 - 0.8	15	0.6
	BV-3P-25S	0.03 - 3.0	0.1 - 0.8	25	0.9
	BV-7V-25S	0.2 - 7.5	0.05 - 0.8	25	3.5
	BV-25V-25S	2 - 25	0.1 - 0.8	25	4.0
	BV-25V-40S	2 - 25	0.1 - 0.8	40	4.0
	N50BV-5V-FS	2.5 - 50	0.15 - 0.5	50	20
	N50BV-5V2-FS	2.5 - 50	0.15 - 0.5	50	20
	N65-50BV-5V-FS	5 - 70	0.15 - 0.5	65	20
	N65-50BV-5V2-FS	5 - 70	0.15 - 0.5	65	20
	SUS	BV-256-15S	0.02 - 2.0	0.05 - 0.8	15
BV-756-25S		0.2 - 7.5	0.05 - 0.8	25	6
BV-2556-25S		2 - 25	0.1 - 0.8	25	7.0
BV-2556-40S		2 - 25	0.1 - 0.8	40	7.5
N50BV-556-FS		2.5 - 80	0.15 - 0.5	50	29
N65BV-556-FS		5 - 120	0.15 - 0.5	65	42

□ : Symbol for material of O-ring ("V" for FKM, "E" for EPDM)

O-ring material of N type is CR for "5V" and FKM for "5V2".

Note: Material for diaphragm is PTFE except BV-1P and N type.

O-Ring material for "BV-1P" and "N" type is same as diaphragm material.



<https://www.iwaki.it>

IWAKI Europe Branch Italy, Via Stazione 7, 36035 Marano Vicentino (VI), Italy  
TEL: +39-0445/561-219 FAX: +39-0445/569-088 E-Mail: sales@iwaki.de

 **Caution for safety use:**  
Before use of pump, read instruction manual carefully to use the product correctly.

Actual pumps may differ from the photos. Specifications and dimensions are subject to change without prior notice. For further details please contact us.

 **Legal attention related to export.**

Our products and/or parts of products fall in the category of goods contained in control list of international regime for export control. Please be reminded that export license could be required when products are exported due to export control regulations of countries.

The posting and copying from this catalogue without permission is not accepted firmly.